

# SRCM

Room Pressure Monitor  
w/BACnet® Option



## “2 in 1” Eliminates need for 2nd Monitor

- Display both Pressure and Room Condition
- On-Board and Remote Sensing Capability

## High Resolution Color Touch-Screen Display

- Immediate Feedback on Room Status
- Intuitive Graphic Interface

## Flush-Mount Design

- Low Profile, Easy-Care Wipe Down
- Snap-in Cover Plate - No Visible Fasteners



## Low Cost Installation

- Clone Configuration Capability
- Standard Off-The-Shelf Electrical Box

setra

# The Solution with a SmartTouch™ Display

In a hospital, laboratory, or animal research facility, the integrity of the ventilation control system is at the heart of a contaminant free environment. Whether a room is to be maintained at a negative pressure to prevent contaminants from escaping into adjacent areas or positive pressure to protect patients with compromised immune systems, the proper pressurization of the room is essential. To assure proper pressurization is maintained in these

critical environments, a room pressure monitor is employed to measure and alert staff and personnel of any change in pressure—no matter how small. A fail-safe solution to monitoring these very low pressure changes is Setra's Model SRCM room pressure monitor, which utilizes highly accurate capacitance sensing technology to measure and display true low pressure differential to a resolution of 0.0001 in. W.C.

## Setra's "2 in 1" Solution

*The Environment is Critical, the Control is Easy*

### Room Condition

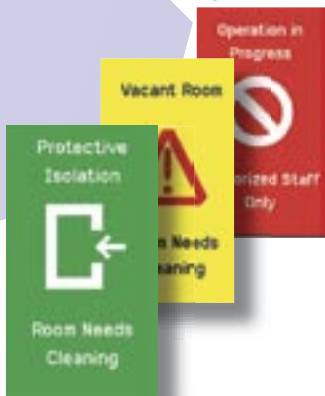

### Room Pressure

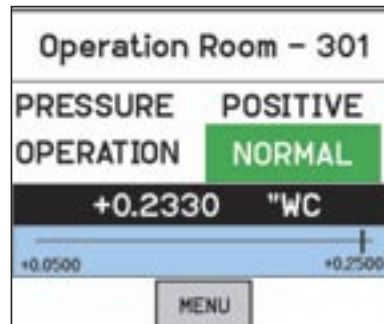

### SRCM



## Attractive, Intuitive, and Configurable Design

### Room Condition Banner

User Configurable Status Display  
 Green = "Clear to Enter"  
 Yellow = "Caution"  
 Red = "Do Not Enter"

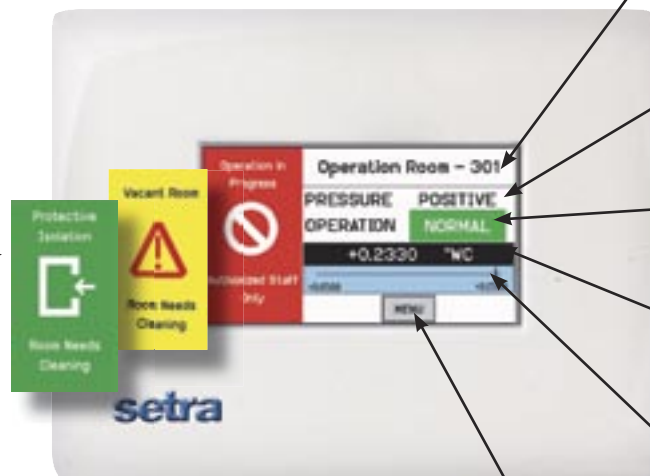

### Room I.D.

Customer Configurable Feature - Customize Room Name

### Room Pressure Mode

Display Positive, Negative, or Neutral Mode of Room

### Room Pressure Status

Visual Indication of Normal, Warning, and Alarm Condition

### Displayed Pressure

Displays Room Pressure in User Selectable Units

### Pressure Slide Bar

Graphic Display of Pressure Reading Relative to Alarm Setpoints

### Setup Menu

Password Protected Entry to Menu Structure

# Features & Benefits



## True Pressure Measurement

- High accuracy Setra low differential capacitance technology
- Dead ended solution — no contamination or clogging
- Standard on-board sensor and optional remote sensor — “2 measurements in 1”

## Flush Mount Design

- No visible mounting fasteners
- Snap-in flush bezel
- Face is sealed for cleaning or wipe-down

## Ease of Installation

- Mounts in off-the-shelf electrical gang box
- 4-screw “self leveling” mount
- Labeled, removable termination strips — ease of wiring

## Clone Configuration

- Display rotates up for access to USB port
- On-board USB port — cloning of configurations for multiple unit installation

## BACnet® Communications

- Installed or field upgrade for in-situ installation
- BACnet® MSTP/ASC
- All setups configurable through touch screen display

## Alarm Capabilities

- Local Audible and Visual alarming
- Remote annunciator alarming capability
- Alarm delay feature — prevent nuisance alarms

## Fingertip Access for Easy Setup

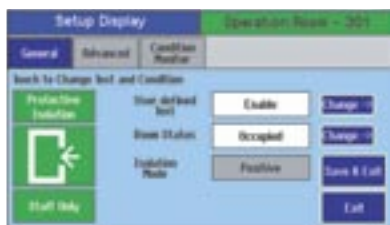

### Setup Display Banner

- User Defined Text: Free form data entry for room name
- Room Status: Change room from Isolation to No Isolation



### Setup Display Advanced

- Display Contrast: Change brightness of display
- Display Averaging: Improve display resolution in unstable ambient pressure environments
- Displayed Pressure: Display primary and secondary or toggle between 2 rooms
- Enable Password: Administrator and Supervisor

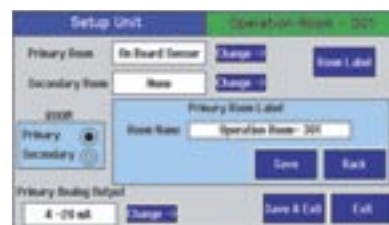

### Setup Unit Operation

- Setup primary and secondary room
- Change analog output
- Free form data entry for room name



Surgical Suites



Pharmaceutical

Intensive Care  
Isolation Rooms



Applications



Organic Laboratory

Research Laboratories



Animal Research

# Model SRCM Specifications

## Performance Data

	<b>Code F</b>	<b>Code H</b>
Accuracy RSS* (at constant temp)	±0.25%	±0.5%
Non-Linearity (BFSL Based)	±0.24%	±0.49%
Hysteresis	±0.05%	±0.05%
Non-Repeatability	±0.05%	±0.05%
Zero Setting Tolerance	±0.5% FS	±0.5% FS
Span Setting Tolerance	±0.5% FS	±0.5% FS

### Thermal Effects\*\*

Compensated Range °F(°C)	±0.03% FS(±0.05% FS)
Overpressure	±1 PSI (15" W.C. for ≤ 0.10" W.C. F.S.)

\*RSS of Non-Linearity, Non-Repeatability and Hysteresis.

\*\*Units calibrated at nominal 70°F. Maximum thermal error computed from this datum.

## Environmental Data

Temperature	
Operating* °F (°C)	32 to +120 (0 to +50)
Storage °F (°C)	-20 to +160 (-30 to +70)
Operating Humidity	5 to 95% RH (Non-condensing)

\*Operating temperature limits of the electronics only.

## Pressure Media

Air or Non-conductive, Non-explosive Gases.

## Physical Description

Case	Fire Retardant Plastic UL94 V-0
Dimensions	5.84"H x 7.45"W x 0.38"D (14.84 x 18.92 x 0.95 cm)
Electrical Connection	Removable Terminal Block
Pressure Fittings	Barbed Fittings for 1/4" Tubing
Weight (approx.)	1lb 3.2oz (554 grams)
Mounting	Mounts to triple gang double-deep electrical box.

### Communications Option

BACnet® MS/TP ASC

## Display

LCD 4.3" TFT, 480 x 272, Dimmable

## Electrical Data (Voltage)

Circuit	3-Wire (Exc., Out, Com)
Output*	0 to 5 VDC 0 to 10 VDC
Excitation	18-32 VAC, 50-60 HZ
Power Consumption	10 W max., 3 W typ.
Alarm Output	SPDT Relay: 0.6A @ 120 VAC 2A @ 30 VDC

\*Calibrated into a 50K ohm load, operable into a 5000 ohm load or greater.

## Electrical Data (Current)

Circuit	2-Wire
Output	4 to 20 mA
External Load	0 to 510 ohms
Excitation	18-32 VAC

## Inputs

1 Internal Pressure Sensor  
2 A/D's inputs for remote pressure sensors  
1 Digital Input

## Certifications

CE Electro-Magnetic Compatibility Directive 2004/108 EC

Specifications are subject to change without notice.

## Outline Drawings

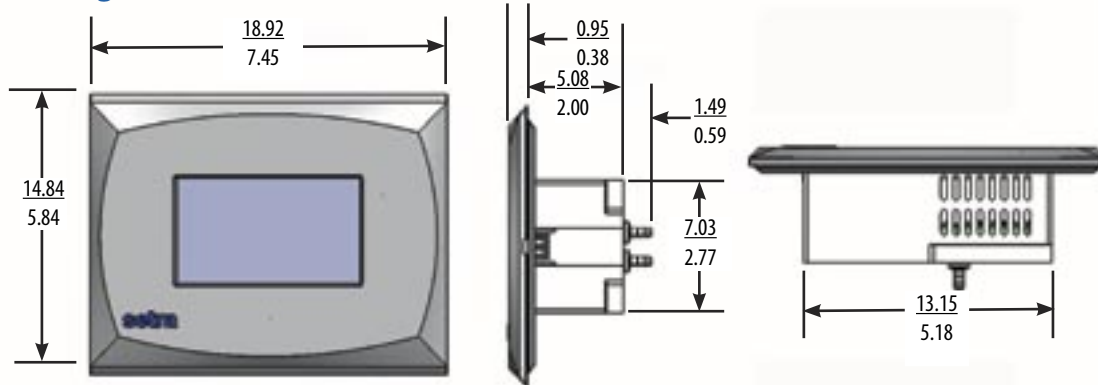

cm  
in.

Example: Part No. SRCMR05WBA1HNS for a SRCM ±0.05" WC Range, 24VAC/4-20 MA, ±0.5% Full Scale Accuracy

S	R	C	M					S			
Model SRCM				Ranges		Excitation/Output		Accuracy		Pressure Snubber	
				Unidirectional/Bidirectional		A1 = 24 VAC/4-20 mA or 0-5 and 0-10 VDC A2 = 24 VAC w/BACnet®		H = ±0.5% Full Scale F = ±0.25% Full Scale		N = 0 1 = 1 2 = 2	
				R05WB = ±0.05" W.C. OR1WB = ±0.10" W.C. R25WB = ±0.25" W.C. OR5WB = ±0.50" W.C. 001WB = ±1.00" W.C. 2R5WB = ±2.50" W.C. 005WB = ±5.00" W.C. 025LB = ±25 Pa 050LB = ±50 Pa 100LB = ±100 Pa 250LB = ±250 Pa 500LB = ±500 Pa 10CLB = ±1000 Pa							
Please contact factory for versions not shown.											
"BACnet" is a registered trademark of ASHRAE											

### Accessories



**Model SRAN Remote Annunciator**  
Green LED, Normal Indication  
Red LED, Alarm Indication  
Buzzer, Audio Alarm, ADJ. from SRPM Acknowledge Switch

**Order Part Number**  
S R A N